

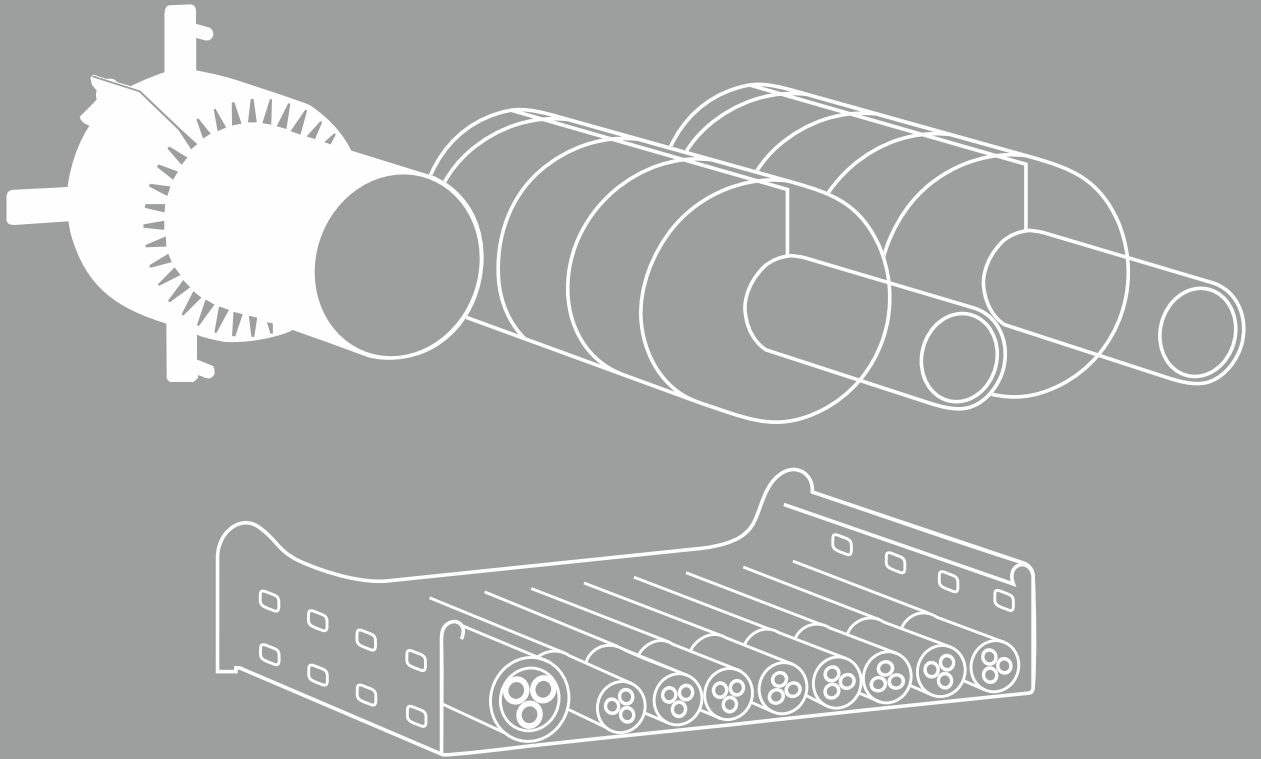

# 17

## YANGIN DURDURUCU ÜRÜNLER



[www.ayangin.com](http://www.ayangin.com)



**2001**  
İZMİR TEKNİK MALZEME  
İŞ MERKEZİNDE KURULDUK



**2015**  
TS EN 14540:2014  
YASSI YANGIN SÖNDÜRME  
HORTUMLARI, ÜRETİMİNE BAŞLADIK



**2004**  
TS 12259  
VANA ÜRETİMİNE BAŞLADIK



**2016**  
YANGIN POMPASI  
ÜRETİMİNE BAŞLADIK



**2004**  
KARA İTFAİYESİNDE KULLANILAN  
YANGIN HORTUMLARI İÇİN  
KAPLIN, REDÜKSİYON (ALÜMİNYUM)  
RAKOR ve LANS ÜRETİMİNE  
BAŞLADIK



**2016**  
TS EN 16034 BELGELİ OLARAK  
YANGIN KAPISI  
ÜRETİMİNE BAŞLADIK



**2006**  
YANGIN DOLABI  
ÜRETİMİNE BAŞLADIK



**2016**  
TS EN 14384 YERÜSTÜ YANGIN  
HİDRANLARI ÜRETİMİNE  
BAŞLADIK



**2007**  
KÖPÜK ORANLAYICI  
MİKSER ÜRETİMİNE BAŞLADIK



**2016**  
İSTANBUL'DA MARMARA BÖLGE  
MÜDÜRLÜĞÜMÜZ FAALİYETE GEÇTİ



**2007**  
HOREKS MARKASINI  
KURARAK YANGIN HORTUMU  
ÜRETİMİNE BAŞLADIK



**2016**  
YANGIN SÖNDÜRÜCÜ  
KİMYEVİ TOZLARIN  
ÜRETİMİNE BAŞLADIK



**2009**  
DENİZ İTFAİYESİNDE KULLANILAN  
YANGIN HORTUMLARI İÇİN PİRİNÇ  
RAKOR ÜRETİMİNE BAŞLADIK



**2016**  
SEYYAR YANGIN SÖNDÜRÜCÜ  
CİHAZLARIN ÜRETİMİNE BAŞLADIK



**2013**  
ANKARA'DA ANADOLU & KARADENİZ  
BÖLGE MÜDÜRLÜĞÜMÜZ  
FAALİYETE GEÇTİ



**2017**  
DAVLUMBAZ YANGIN  
SÖNDÜRME SİSTEMİ ÜRETİMİNE  
BAŞLADIK



**2014**  
AYRANCILAR SANAYİ BÖLGESİNDE  
FABRİKAMIZI KURDUK



**2017**  
YANGINA DAYANIKLI  
YAPI KİMYASALLARI ÜRETİMİNE  
BAŞLADIK



2001 yılında kurulan A Yangın Güvenlik Sistemleri San. Tic. A.Ş. yangın söndürme sistemleri, yangına müdahale ve yangından korunma ile itfaiye ekipmanları alanında hizmet vermektedir.

210 uzman çalışanı ile, 15.000 m<sup>2</sup> üretim alanında teknolojik makineler ile seri üretim yapmaktayız. Yangın sektöründe 10 farklı kategoride üretim yaparak lider kuruluş olmayı başaran A Yangın A.Ş. olarak iç ve dış piyasada ürünlerimizi daha iyi tanıtmak, müşteri yelpazemizi genişletip ilişkilerimizi arttırmak amacıyla, İstanbul'da Marmara Bölge Müdürlüğü, Ankara'da Anadolu & Karadeniz Bölge Müdürlüklerimizi faaliyete geçirmiş bulunmaktayız.

A Yangın A.Ş. teknolojik olarak üretim faaliyetlerine, üretim yapısını teşkil eden gelişmiş makine parkını yeni nesil Robotik CNC makineleri ile takviye etmekte ve müşteri isteğine dönük her türlü ihtiyaca özel kalıpları (Plastik Enjeksiyon ve Metal Enjeksiyon) kendi bünyesinde üretebilmektedir. Konusunda uzman Mühendis kadrosu ile Türkiye'de ve dış ülkelerdeki endüstriyel tesis, enerji merkezleri, konut, ofis, rezidans, alışveriş merkezi ve otellerin yangın güvenliğinin projelendirilmesi ve uygulamalarının yapılması işlemini gerçekleştirmektedir.

A Yangın A.Ş. , yaşam güvenliği çözümleri üretmekte olup, Türkiye'nin en kapsamlı yangın söndürme ve güvenlik ekipmanları üreten tek firmasıdır.

## KALİTE BELGELERİMİZ

- |   |   |
|---|---|
|  TS EN ISO 9908 Santfirij Pompalar               |  TS 9222 Bez Yassı Hortumlar                         |
|  TS EN 14384 Yangın Hortumları                   |  TS EN 14540:2014 Hortumlar                          |
|  TS EN 16034 Yangın Kapıları                     |  TS EN 694 : 2014 Yarı Sert Hortumlar                |
|  TS EN 671-1 1" Sulu Sistem Yangın Dolapları CE  |  TS 745 EN ISO 2398 Sızıntı Yapmayan Hava Hortumları |
|  TS EN 671-2 2" Sulu Sistem Yangın Dolapları CE  |  TS 12258 Kaplinler ve Redüksiyonlar                 |
|  TS 862-7 EN 3-7+A1 Yangın Söndürme Cihazları CE |  TS 2323 Hortum Rakorları (Deniz İtfaiyesi İçin)     |
|  TS EN 1866-1 Mobil Yangın Söndürme Cihazları CE |  TS 12259 Vanalar                                    |
|  TS EN 615 : 2011 Yangın Söndürücü Kimyasallar   |  TS 3145 Lanslar                                     |
|  TSE UBM - 00 - BK - 000 Köpük Jeneratörleri     |  TSEK ÜBM-00-BK-000 PAKET HİDROFORLAR                |
|   |  Hizmet Yeterlilik Belgesi                           |

## ISO 9001:2015 KALİTE YÖNETİM SİSTEMLERİ







**ÜRÜN GRUPLARI / FAALİYETLERİMİZ**

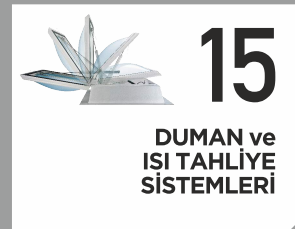
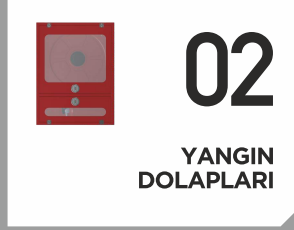

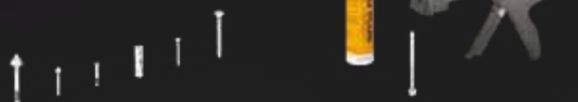
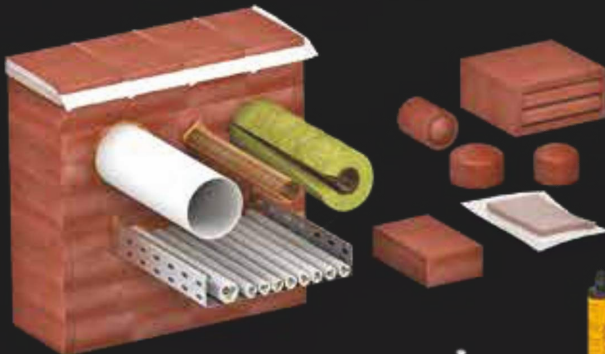

## BÖLÜM 17-YANGIN DURDURUCU ÜRÜNLER

### 1- AMAÇ: Yangın Çıkma İhtimali Yüksek Olan Bölümlerin İzole Edilmesi

Binanın yangın çıkma ihtimali yüksek olan bölümlerinin (Elektrik odası vs.) geri kalan bölümlerinden izole edilmesi esas amaçtır. Bu bölümler genelde yangına dayanımlı duvarlarla çevrelenir. Bu bölümdeki olası yangın alevinin ve dumanının diğer bölümlere belli bir zaman süresince geçmemesi amaçlanır.



### 2- AMAÇ: Acil Çıkış Yollarının Güvenliğinin Sağlanması

Yangın yönetmeliğine göre acil durumda binadaki insanların tahliyesi amacı ile kullanılan yollardır. Yangının tüm olumsuz etkilerinin (alev, duman vs.) bu yollarla sirayet etmemesi ve bu yolların daima açık tutulması gerekmektedir. Bu yollar sadece tahliye yolu değil aynı zamanda itfaiyenin binaya giriş yollarıdır. Bir yangın durumunda ölümlerin %95'inin dumandan kaynaklandığı unutulmamalıdır.



### 3- AMAÇ: Elektrikle Çalışan Sistemlerin Çalışmaya Devam Etmesi

E30 - 30 dakika boyunca, Acil Aydınlatma Sistemleri, Yangın Asansörleri, Yangın Alarm Sistemleri, Tahliye Anons Sistemleri, Duman Tahliye Sistemleri çalışmalıdır.

E90 - 90 dakika boyunca, Yangın Pompası, Yangın Söndürme Suyu Basınçlandırma Sistemi, Mekanik Duman Tahliye Sistemleri, İtfaiye Asansörleri, Hastanelerde Sedye Tahliye Asansörleri çalışmalıdır. Tüm bu sistemlerde kullanılan "F" yangın kablolarının bu şekildeki askı ve montaj sistemleri ile monte edilmesi gerekmektedir.

Acil çıkış yollarının tamamen dumandan ve alevden korunması gereklidir.







**Pyromix**



**YANGIN DURDURUCU HARÇ**

**Yangın Durdurucu Harç Pyromix**

ÜRÜN KODU	TİP	TANIM	MİNİMUM AMBALAJ BASKILARI
4-26-01-000001	MSX-S1	20 kg	1

Önceden karıştırılmış özel kuru harçtan ibarettir. Su ile karıştırılan bu harç iyi bir zemin tutuş sağlar. Sertleşen harç, mekanik olarak katı bir kablo geçit dolgusu oluşturur. 6 litre su ilave edilerek kullanılır. DIN 4102-9'a uygundur. Sertifika: Z-19.15-2046, S 90

**Dolgu Malzemesi**

ÜRÜN KODU	TİP	TANIM	MİNİMUM AMBALAJ BASKILARI
4-26-01-000002	DSX-K	0,3 lt	1
4-26-01-000003	DSX-E	5 kg	1

Harç ile birlikte kullanılır.

**Uygulamacı Etiketli**

ÜRÜN KODU	TİP	MİNİMUM AMBALAJ BASKILARI
4-26-01-000004	KS-S EN	1

Yangına dayanımı 90 dakika, Sertifika: Z-19.22-1891.



## YANGIN DURDURUCU PLAKA - PYROPLATE



Pyroplate

### YANGIN DURDURUCU PLAKA

#### Yangın Durdurucu Plaka (PYROPLATE)

ÜRÜN KODU	TİP	TANIM	MİNİMUM AMBALAJ BASKILARI
4-26-01-000005	PSX-P	1000x600x50 mm	2

Yangına dayanıklılık süresi 90 dakikadır. DIN 4102-9'a uygundur.

#### Yüzey Kaplama Malzemesi

ÜRÜN KODU	TİP	TANIM	MİNİMUM AMBALAJ BASKILARI
4-26-01-000006	ASX-K	0,3 lt	1
4-26-01-000007	ASX-E	5 kg	1

Plakanın kesilen kenarlarını ve plaka dışına taşankabloların üzerine 15 cm boyunca sürülür.

#### Uygulamacı Etiketli

ÜRÜN KODU	TİP	MİNİMUM AMBALAJ BASKILARI
4-26-01-000008	KS-S EN	1

Yangına dayanımı 90 dakika, Sertifika: Z-19.22-1891

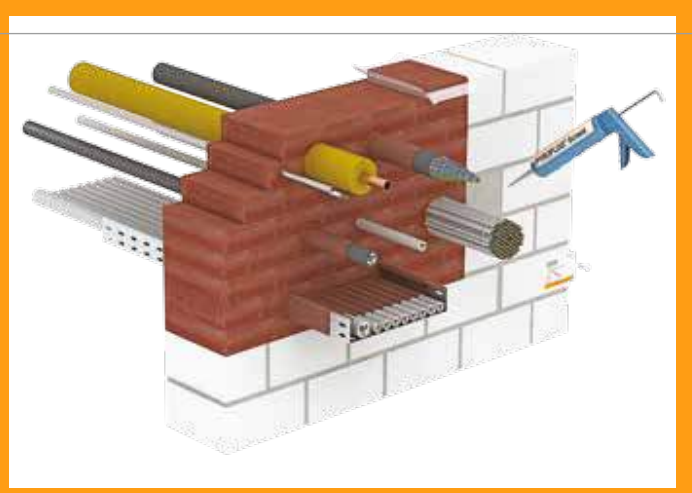
**Pyroplug**
**YANGIN DURDURUCU BLOK PYROPLUG**

ÜRÜN KODU	TİP	TANIM	MİNİMUM AMBALAJ BASKILARI
4-26-01-000009	FBA-B200-14	200x120x60	200x144x60
4-26-01-000010	FBA-BV200-14	200x120x25 Vakum Blok	200x144x25 Vakum Blok
4-26-01-000011	FBA-F	250x120x80	200x200x100

Yangına dayanım sınıfı: S90, Sertifika: Z-19.15-1849. İslanmamalıdır.  
B120 Blok EN 1366-3 standardına uygundur.

**Boşluk Doldurma Malzemesi**

ÜRÜN KODU	TİP	TANIM	MİNİMUM AMBALAJ BASKILARI
4-26-01-000033	FBA-SP	0,31 LT	1

Yangına dayanım sınıfı: S90, Sertifika: Z-19.15-1849. İslanmamalıdır.  
B120 Blok EN 1366-3 standardına uygundur.

**Uygulamacı Etiketi**

ÜRÜN KODU	TİP	MİNİMUM AMBALAJ BASKILARI
4-26-01-000034	KS-S EN	1

Yangına dayanımı 90 dakika, Sertifika: Z-19.22-1891

## YANGIN DURDURUCU KÖPÜK - PYROSİT



Pyrosit

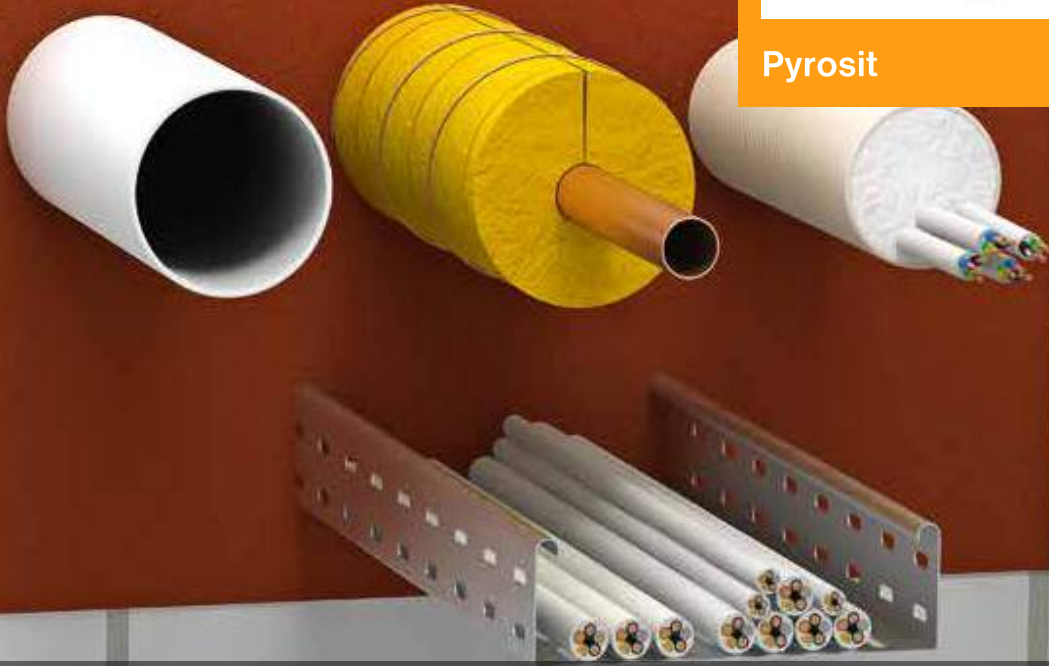

### YANGIN DURDURUCU KÖPÜK

#### Pyrosit

ÜRÜN KODU	TİP	TANIM	MİNİMUM AMBALAJ BASKILARI
4-26-01-000035	FBS-S	0,38 lt	1

EN 1366-3'e uygundur. Yangına dayanım sınıfı: EI 120. Uygulama tabancası ve uçları ile birlikte kullanılır. İçinde 2 kimyasal madde bulunur. Bu kimyasallar tabanca ile uygulama esnasında, uygulama ucunda karışır. Nüfuz ettiği yerde şişerek geçişi tamamen kapatır.

#### Pyrosit Uygulama Tabancası ve Uygulama Ucu

ÜRÜN KODU	TİP	MİNİMUM AMBALAJ BASKILARI
4-26-01-000036	FBS-M	2
4-26-01-000037	FBS-K	1

10 adet karıştırıcı uç ve 5 adet uzatma ucu birlikte gelir.

#### Uygulama Etiketi

ÜRÜN KODU	TİP	TANIM	MİNİMUM AMBALAJ BASKILARI
4-26-01-000038	KS-S EN		1

Yangına dayanımı 90 dakika, Sertifika: Z-19.22-1891.

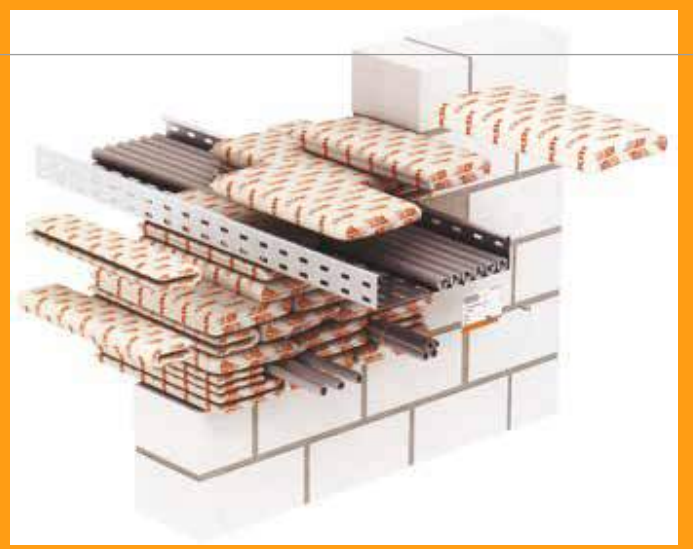

**Pyrobag**

**YANGIN DURDURUCU YASTIK**

**Yangın Durdurucu Yastık (PYROBAG)**

ÜRÜN KODU	TİP	TANIM	MİNİMUM AMBALAJ BASKILARI
4-26-01-000047	KBK-1	120x10	20
4-26-01-000048	KBK-2	170x23	20
4-26-01-000049	KBK-3	170x40	10

Yangına dayanım sınıfı: S90, Sertifika: Z-19.15-1115

**Uygulamacı Etiketli**

ÜRÜN KODU	TİP	MİNİMUM AMBALAJ BASKILARI
4-26-01-000034	KS-S-EN	1

Yangına dayanımı 90 dakika, Sertifika: Z-19.22-1891

## YANGIN DURDURUCU KÖPÜK - PYROSIT



Pyroline

### YANGIN DURDURUCU KANAL

#### Yangın Durdurucu Yastık (PYROBAG)

ÜRÜN KODU	TİP	h (mm)	b (mm)	H (mm)	B (mm)	Uzunluk (mm)	Minimum Ambalaj Miktarı
4-26-01-000039	BSKM 0711	70	110	70	110	2	2
4-26-01-000040	BSKM 1025	100	250	100	250	2	2
4-26-01-000041	BSK 090506	50	60	95	120	1	1
4-26-01-000042	BSK 090511	50	110	95	170	1	1
4-26-01-000043	BSK 090521	50	210	95	210	1	1

Yangına dayanım sınıfı: I 30 - I 120, DIN 4102-11'e uygundur.

#### Kanal Montaj Bandı

ÜRÜN KODU	TİP	ÖLÇÜLER (mm)	TANIM (mt)	MINİMUM AMBALAJ MİKTARI
4-26-01-000044	BK-D0930	5x30	15	1

#### Kanal Montaj Civatası

ÜRÜN KODU	TİP	ÖLÇÜLER (mm)	Minimum Ambalaj Miktarı
4-26-01-000045	BSK-S0955	4x55	50

**Pyrocomb**

**YANGINA DAYANIKLI BORU TUTUCULAR**
**Yangın Durdurucu Boru Tutucular (PYROCOMB)**

ÜRÜN KODU	BORU ÇAP (mm)	GENİŞLİK (mm)	İÇ ÇAP (mm)	DIŞ ÇAP (mm)	MİN. AMB. MİK.
4-26-01-000017	TCX-032	32	26	36	1
4-26-01-000018	TCX-040	40	26	44	1
4-26-01-000019	TCX-050	50	26	54	1
4-26-01-000020	TCX-063	63	26	67	1
4-26-01-000021	TCX-075	75	26	79	1
4-26-01-000022	TCX-090	90	26,6	94	1
4-26-01-000023	TCX-110	110	26,6	114	1
4-26-01-000024	TCX-125	125	40	129	1
4-26-01-000025	TCX-140	140	40	144	1
4-26-01-000026	TCX-160	160	40	164	1

EN 1366-3'e uygundur. Yangına dayanım sınıfı: EI 120. Uygulama tabancası ve uçları ile birlikte kullanılır. İçinde 2 kimyasal madde bulunur. Bu kimyasallar tabanca ile uygulama esnasında, uygulama ucunda karışır. Nüfuz ettiği yerde şişerek geçişi tamamen kapatır.

## YANGINA DAYANIKLI BANDAJ - PYROWRAP



Pyrowrap



### YANGIN DURDURUCU BANDAJ

#### Yangın Durdurucu Boru Tutucular (PYROCOMB)

ÜRÜN KODU	TİP	ÖLÇÜLER (mm)	TANIM (mt)	MİNİMUM AMBALAJ MİKTARI
4-26-01-000011	FSB-BS	1100x10000		1
4-26-01-000012	FSB-WB	1100x20000	Suya Dayanaklı	1

Yangına dayanımı 90 dakika, Sertifika: Z-19.11-1892

#### Bandaj Gergi Bandı

ÜRÜN KODU	TİP	B (mm)	L (mt)	MİNİMUM AMBALAJ MİKTARI
4-26-01-000013	MBS 015	7	150	100
4-26-01-000014	MBS 030	7	300	100
4-26-01-000015	MBS 045	7	450	50
4-26-01-000016	MBS 060	7	600	50

Dikey shaft geçişleri için destek kafesi



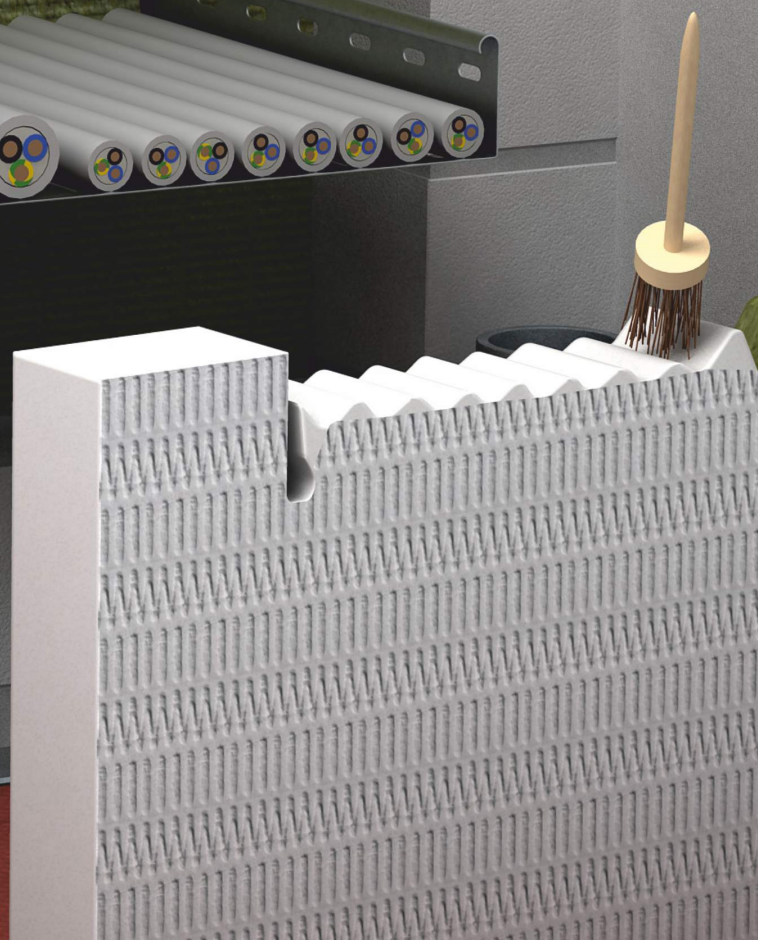
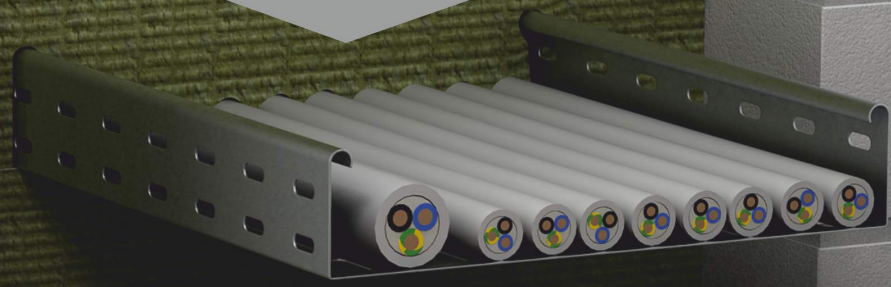



**Sizin için, Türkiye için ve Dünya için üretiyoruz**



**A YANGIN GÜVENLİK A.Ş.**

**Genel Müdürlük & Fabrika**

 İnönü Mah. Yavuz Sultan Selim Cad. No:81  
Ayrancılar-Torbalı / İZMİR  
 +90 232 257 69 40 - 41 / 257 68 10 / 854 62 94  
 +90 232 257 61 88 - 89  
 [ayangin@ayangin.com](mailto:ayangin@ayangin.com) / [import-export@ayangin.com](mailto:import-export@ayangin.com)

**Marmara Bölge Müdürlüğü**

 Acıbadem Mah. Çeçen Sokak Akasya  
Acıbadem Kent Etabı No:25B, B Blok, B1 Giriş  
K:6 D:78 Acıbadem-Üsküdar/İSTANBUL  
 +90 216 577 71 97 (Pbx) +90 216 577 71 95  
 +90 216 577 71 96  
 [marmarasatis@ayangin.com](mailto:marmarasatis@ayangin.com)

**Anadolu & Karadeniz Bölge Müdürlüğü**

 İvedik Organize San. Böl. 1354 Cad.  
1388 Sk. No:2 Yenimahalle / ANKARA  
 +90 312 394 83 72 - 74  
 +90 312 394 83 77  
 [ankarasatis@ayangin.com](mailto:ankarasatis@ayangin.com)